

Technical File

Kasual Line - Desk Fix

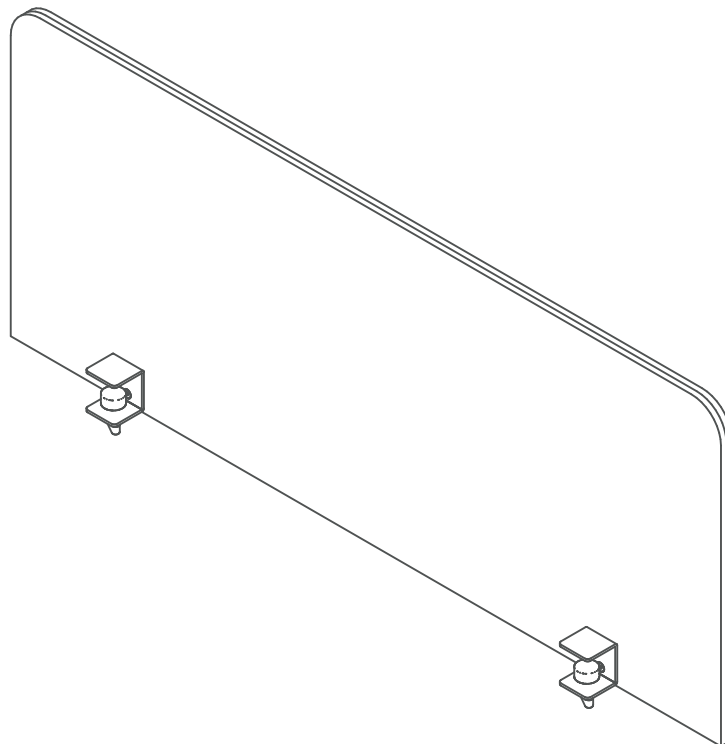

01

Dimensions

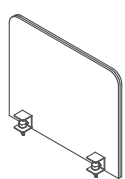
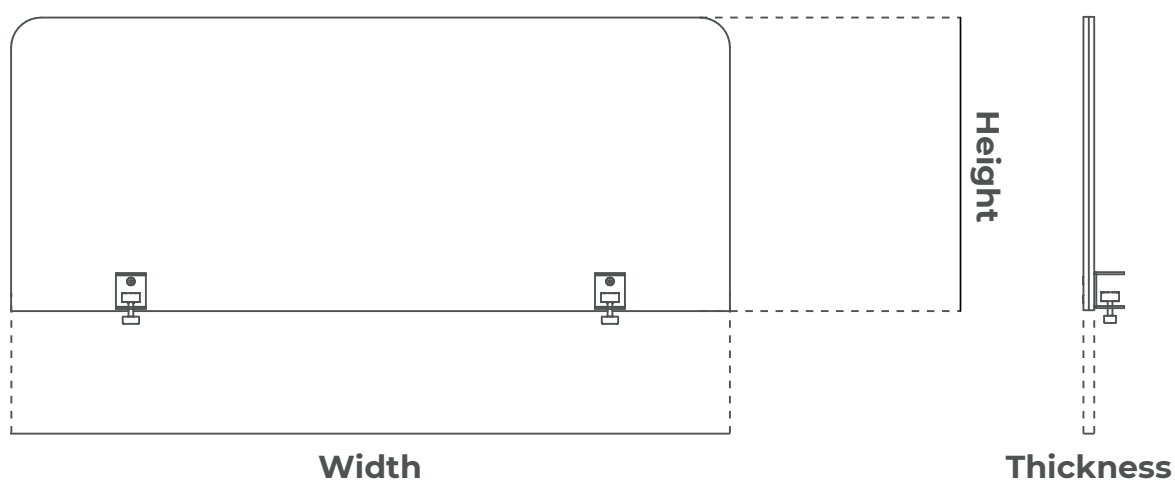

Desk Fix
LATERAL

Width: 600mm Height: 490mm Thickness: 20mm

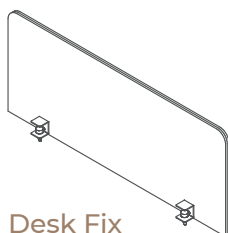

Desk Fix
FRONTAL

Width: 1200mm Height: 490mm Thickness: 20mm
Width: 1400mm Height: 490mm Thickness: 20mm

02

Finishes

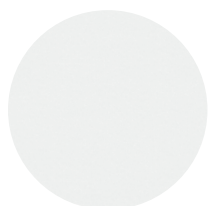

Composition 100% Polyester
Weight 200 gr/m²
Thickness 1,75 mm
Colour Fastness to light EN ISO 105-B02: 6-7
Flame Retardancy EN 13501-1: B-s1,d0
Abrasion resistance 50 000 Cycles
STANDARD 100 by OEKO-TEX®

Felt | Solid Colour
Pearl

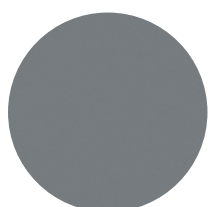

Composition 100% Polyester
Weight 200 gr/m²
Thickness 1,75 mm
Colour Fastness to light EN ISO 105-B02: 6-7
Flame Retardancy EN 13501-1: B-s1,d0
Abrasion resistance 50 000 Cycles
STANDARD 100 by OEKO-TEX®

Felt | Solid Colour
Storm

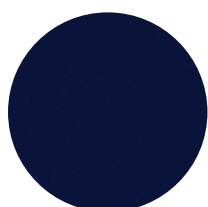

Composition 100% Polyester
Weight 200 gr/m²
Thickness 1,75 mm
Colour Fastness to light EN ISO 105-B02: 6-7
Flame Retardancy EN 13501-1: B-s1,d0
Abrasion resistance 50 000 Cycles
STANDARD 100 by OEKO-TEX®

Felt | Solid Colour
Indigo Blue

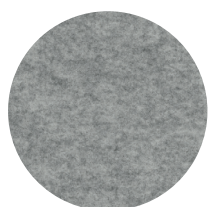

Composition 100% Polyester
Weight 200 gr/m²
Thickness 1,75 mm
Colour Fastness to light EN ISO 105-B02: 6-7
Flame Retardancy EN 13501-1: B-s1,d0
Abrasion resistance 50 000 Cycles
STANDARD 100 by OEKO-TEX®

Felt | Melange Finish
Pewter



Composition 100% Polyester
Weight 200 gr/m²
Thickness 1,75 mm
Colour Fastness to light EN ISO 105-B02: 6-7
Flame Retardancy EN 13501-1: B-s1,d0
Abrasion resistance 50 000 Cycles
STANDARD 100 by OEKO-TEX®

Felt | Melange Finish
Espresso

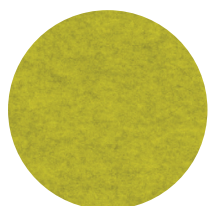

Composition 100% Polyester
Weight 200 gr/m²
Thickness 1,75 mm
Colour Fastness to light EN ISO 105-B02: 6-7
Flame Retardancy EN 13501-1: B-s1,d0
Abrasion resistance 50 000 Cycles
STANDARD 100 by OEKO-TEX®

Felt | Melange Finish
Lemon

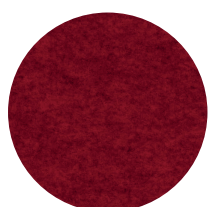

Composition 100% Polyester
Weight 200 gr/m²
Thickness 1,75 mm
Colour Fastness to light EN ISO 105-B02: 6-7
Flame Retardancy EN 13501-1: B-s1,d0
Abrasion resistance 50 000 Cycles
STANDARD 100 by OEKO-TEX®

Felt | Melange Finish
Ruby

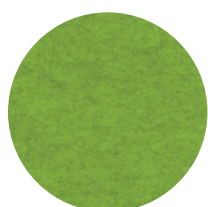

Composition 100% Polyester
Weight 200 gr/m²
Thickness 1,75 mm
Colour Fastness to light EN ISO 105-B02: 6-7
Flame Retardancy EN 13501-1: B-s1,d0
Abrasion resistance 50 000 Cycles
STANDARD 100 by OEKO-TEX®

Felt | Melange Finish
Kelly

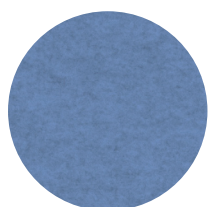

Composition 100% Polyester
Weight 200 gr/m²
Thickness 1,75 mm
Colour Fastness to light EN ISO 105-B02: 6-7
Flame Retardancy EN 13501-1: B-s1,d0
Abrasion resistance 50 000 Cycles
STANDARD 100 by OEKO-TEX®

Felt | Melange Finish
Cerulean

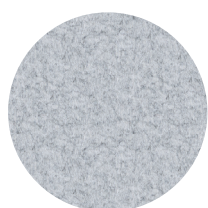

Composition 100% PET
Thickness 9 mm
STANDARD 100 by OEKO-TEX®

PET Finish
Light Grey